

metal + glass + wood - doors

150



150A5-N-AB



150A5-D-N

150A5 - AUDIO

The 150 is a premium quality series featuring high-gloss wood, perforated metal panels and dark glass doors. The 150A5 contains four interior adjustable glass shelves to simplify equipment placement and front doors to protect and hide everything from view. Side and rear metal panels close the cabinet and enable a free air flow recommended for electronic equipment. A simple rear panel wire management system will help keep wires organized and out of view.

PERFORATED METAL PANEL

Perforated metal panels conceal equipment and provide aeration.

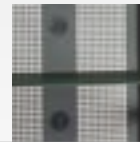

DARK GLASS DOORS

Glass doors hide and protect equipment.



WIRE MANAGEMENT

Wire management helps organize and hide wires.

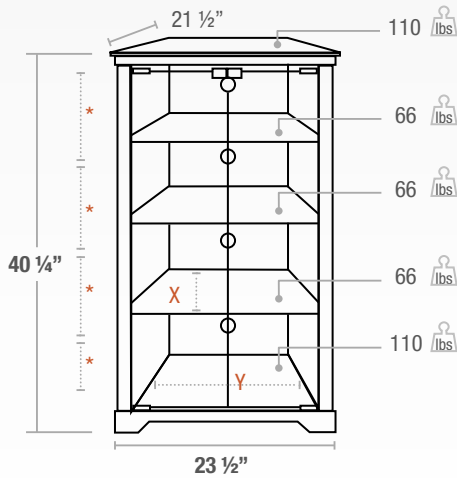
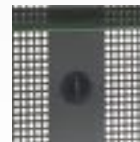

Top Shelf thickness 25 mm

Lower Shelf thickness 6 mm

*= Middle shelves are adjustable by 2 1/4 inch increments

X= Usable Shelf Depth 19"

Y= Usable Shelf Width 18 1/4"

GLASS DOORS

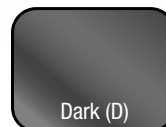

Dark (D)

TOP SHELVES



Cherry (CH)

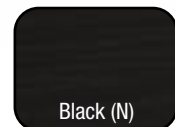

Black (N)



Top view

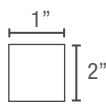

Front posts

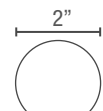

Cable management

metal + glass + wood - doors

150V - VIDEO

The 150 is a premium quality series featuring high-gloss wood, perforated metal panels and dark glass doors. The 150V contains two interior adjustable glass shelves to simplify equipment placement and front doors to protect and hide everything from view. Side and rear metal panels close the cabinet and enable a free air flow recommended for electronic equipment. An inlaid top glass panel creates a distinctive look and protects the stand's surface.



150V-D-N



150V-N-AB

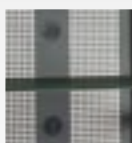

PERFORATED METAL PANEL
Perforated metal panels conceal equipment and provide aeration.



DARK GLASS DOORS
Glass doors hide and protect equipment.



INLAID GLASS
Inlaid glass protects and beautifies stand.

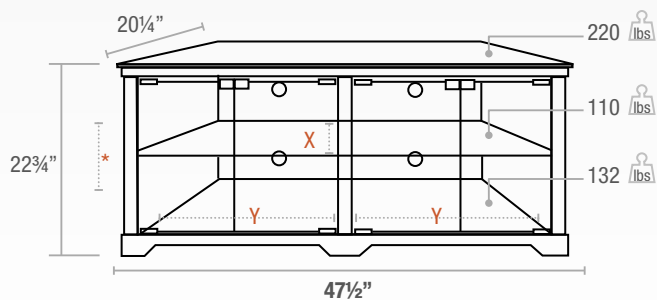

GLASS DOORS

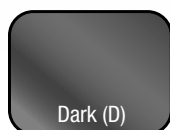

Dark (D)

TOP SHELVES

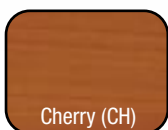

Cherry (CH)

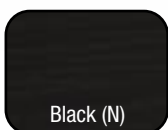

Black (N)

Top Shelf thickness 23 mm
Middle Shelf thickness 6 mm
* = Middle shelves are adjustable by 2 1/2 inch increments

X = Usable Shelf Depth 18 1/2"
Y = Usable Shelf Width 20 3/4"



Top view

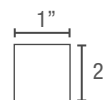

Front posts

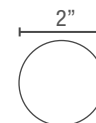

Cable management

150