

# wood + metal



144V-W-N

## 144V SERIES - AUDIO/VIDEO

The 144V series is a beautifully crafted stand. High-gloss bevelled shelves are securely held by a strong 2" black matte square post frame. A heavy-gauge rear support panel provides a convenient wire management system.

144V-N-N



### HIGH-GLOSS SHELVES

High-gloss bevelled shelves create a look of luxury.



144V-CH-N



### WIRE MANAGEMENT

Rear panel provides a convenient wire management system.

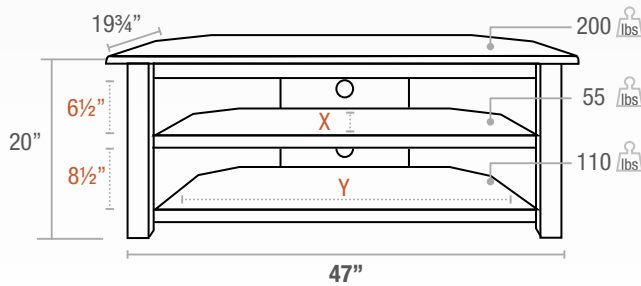
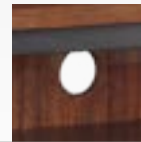

Top Shelf thickness 15 mm  
Lower Shelf thickness 15 mm

X= Usable Shelf Depth 18"  
Y= Usable Shelf Width 40"

### WOOD SHELVES

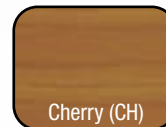

Cherry (CH)

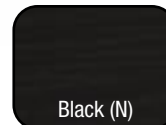

Black (N)

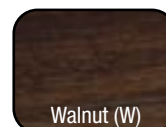

Walnut (W)

### POSTS



Black (N)



Top view



Front posts



Cable management

144A SERIES - AUDIO

The 144A series is a beautifully crafted wood and metal stand. High-gloss bevelled shelves are securely held by a strong 2" black matte square post frame. A heavy-gauge rear support panel provides a convenient wire management system.



144A5-CH-N



**HIGH-GLOSS SHELVES**  
High-gloss bevelled shelves create a look of luxury.

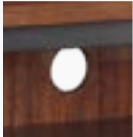

**WIRE MANAGEMENT**  
Rear panel provides a convenient wire management system.



144A5-N-N



144A5-W-N

WOOD SHELVES



POSTS

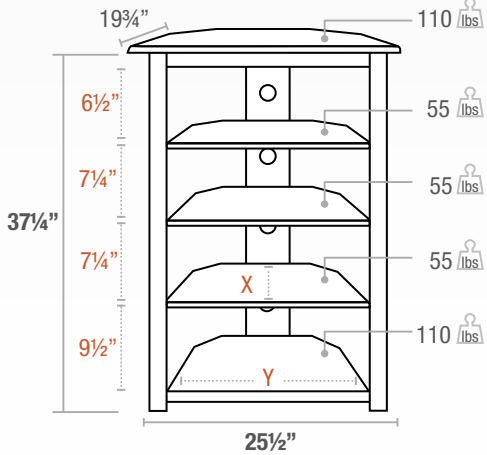
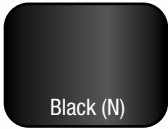

Top Shelf thickness 15 mm  
Lower Shelf thickness 15 mm  
X= Usable Shelf Depth 18"  
Y= Usable Shelf Width 20"

